

# Lecture 26: Networks

David Hovemeyer

April 5, 2021

601.229 Computer Systems Fundamentals



# Using a web browser

Type a URL into a web browser:

`http://placekitten.com/1024/768`

# The internet of cats

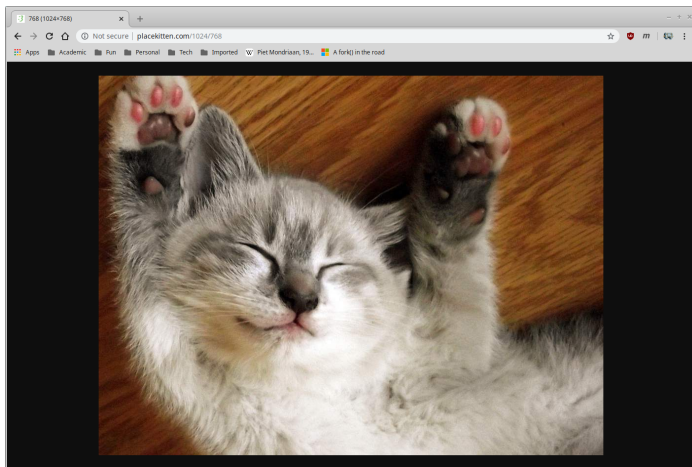

Nice! (But how did that actually work?)

# Networks

Network: allow communication between computers

Access remote data

Share information

Hard to overstate importance of networking: *everything* can communicate over the Internet now (laptops, phones, cars, refrigerators, ...)

# Network interface

To connect to a network, a computing device needs a *network interface*

- ▶ Wired: ethernet, Infiniband (for high-performance applications)
- ▶ Wireless: 802.11 (wifi), cellular modem

To the computing device (the “host”), the network interface is just a peripheral device

- ▶ Much like a disk controller, USB controller, etc.

OS can request to send data out to the network

Network interface device notifies host CPU when data arrives from the network (possibly by raising a hardware interrupt)

# Network interface example

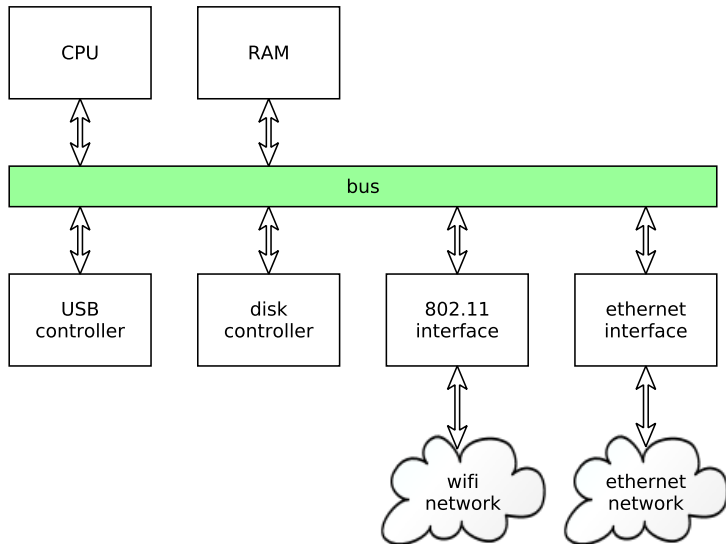

# Protocol stack

In addition to network interface hardware, a *protocol stack* is needed to allow network applications to communicate over the attached network interface(s)

“Protocol stack”: so called because network protocols are layered

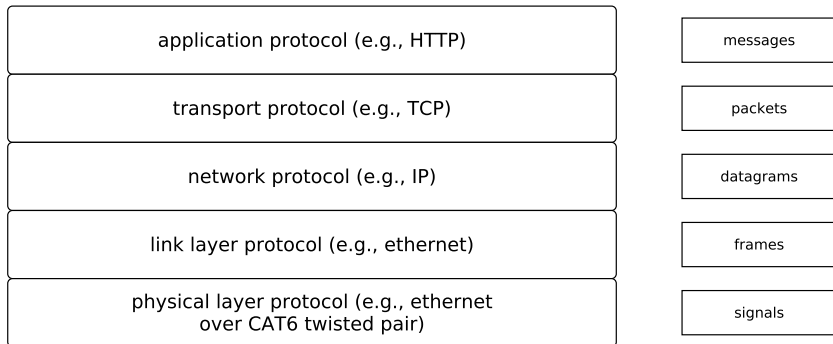



Some important issues to consider:

- ▶ How are differing network technologies interfaced to each other?
- ▶ How are devices and systems identified on the network?
- ▶ How is data routed to the correct destination?
- ▶ What APIs do network applications use to communicate?

We'll cover all of these (at least briefly)

# Network security

Ideal of networking is to provide access to information and computing resources from anywhere

But...connecting a computing device to the network potentially exposes it to malicious actors

Issue: controlling access

- ▶ Permit only authorized agents access to data and services

When implementing and deploying networked systems and applications, we must think *very* carefully about

- ▶ what the security requirements are, and
- ▶ whether the system meets them

# TCP/IP

TCP/IP: a suite of *internetworking* protocols

- ▶ “internetworking” = connecting lots of physical networks together, including when they use different technologies or protocols

Two versions: IPv4 and IPv6

- ▶ IPv4: 32 bit addresses (not enough of these!), widely deployed
- ▶ IPv6: 128 bit addresses, not as widely deployed (but significant adoption in mobile networks)

Ubiquitous: if you're using a network, you're using TCP/IP

Scale of global TCP/IP internet is immense (*billions* of communicating devices)

IP = Internet Protocol

This is the underlying *network protocol* in the TCP/IP protocol suite

Ultimately, all data is sent and received using *IP datagrams*: fixed-size packets of data sent and received using IP addresses to indicate the source and destination

Transport protocols (such as TCP and UDP) are layered on top of IP

- ▶ E.g., a TCP connection consists of IP datagrams containing TCP data

IP is an *unreliable* protocol: when a datagram is sent, it might not reach the recipient (we'll see why in a bit)

# An IP datagram

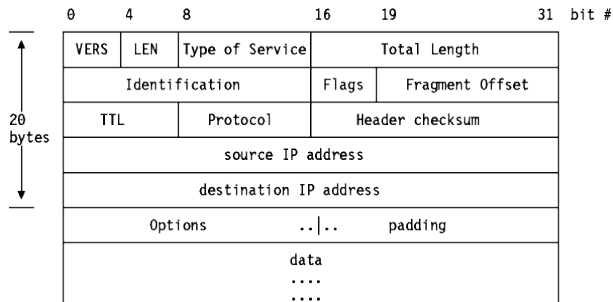

[Image source: <http://www.danzig.us/tcp-ip-lab/ibm-tutorial/3376c23.html>]

## Details:

- ▶ Consists of *header* followed by *data*
- ▶ May be fragmented and reassembled
- ▶ Protocol field indicates which transport protocol is being used

# TCP

TCP: Transmission Control Protocol

A *connection* protocol layed on IP (value in Protocol field is 6)

TCP allows the creation of virtual connections between peer systems on network

A connection is a bidirectional data stream (each peer can send data to the other)

Data is guaranteed to be delivered in the order sent

Connection can be closed (analogy: hanging up when phone call ends)

TCP is a *reliable* protocol: if any data is lost en route, it is automatically resent

- ▶ Much cleverness is required to make this work!

UDP: User Datagram Protocol

A *datagram* protocol layed on IP (value in Protocol field is 17)

Not connection-oriented: data could be received in any order, no fixed duration of conversation (more analogous to sending a letter than talking on the phone)

*Unreliable*: data sent might not be received

Used in applications where minimizing latency is important and data loss can be tolerated



# Routing: idealized

*Routing*: How does data get to its destination?

Idealized view:

# Routing: idealized

*Routing:* How does data get to its destination?

Idealized view:

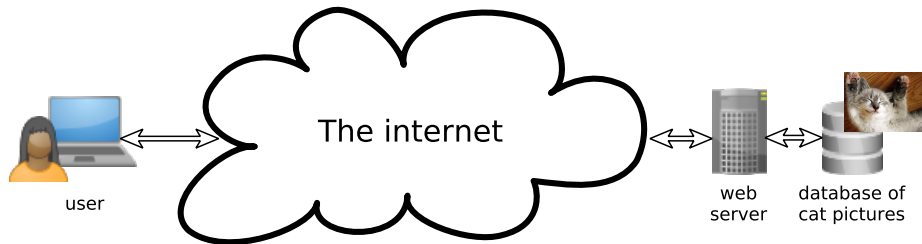

# Routing: the reality

*Routing*: How does data get to its destination?

Slightly more realistic view:

# Routing: the reality

*Routing:* How does data get to its destination?

Slightly more realistic view:

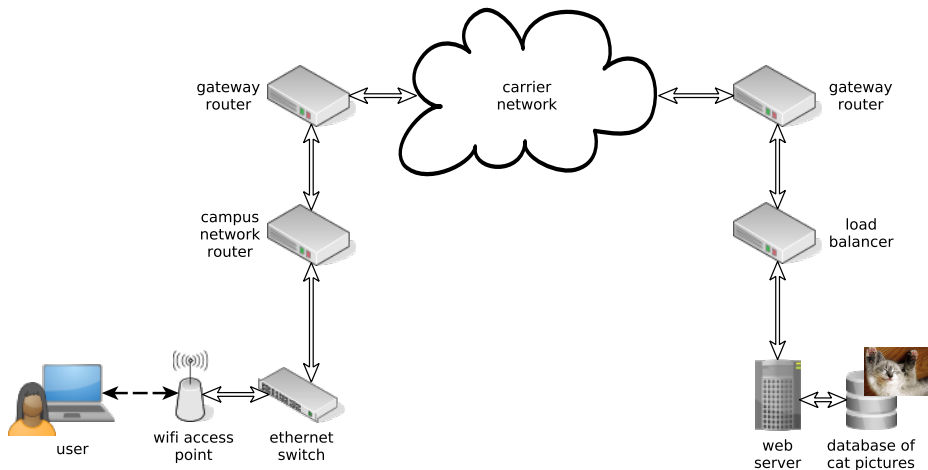

# Addressing

Two kinds of address:

- ▶ Network address: address of a network interface within the overall internet (e.g.: IPv4 address)
- ▶ Hardware address: a hardware-level address of a network interface (e.g.: ethernet MAC address)

# Addressing

Two kinds of address:

- ▶ Network address: address of a network interface within the overall internet (e.g.: IPv4 address)
- ▶ Hardware address: a hardware-level address of a network interface (e.g.: ethernet MAC address)

Network address is used to make routing decisions at the scale of the overall internet

- ▶ Network address conveys information about the network on which the interface can be found
- ▶ A *router* makes routing decisions based on a network address

# Addressing

Two kinds of address:

- ▶ Network address: address of a network interface within the overall internet (e.g.: IPv4 address)
- ▶ Hardware address: a hardware-level address of a network interface (e.g.: ethernet MAC address)

Network address is used to make routing decisions at the scale of the overall internet

- ▶ Network address conveys information about the network on which the interface can be found
- ▶ A *router* makes routing decisions based on a network address

Hardware address is used to deliver a data packet to a destination within the local network

- ▶ A *switch* makes routing decisions based on a hardware address

# Routing

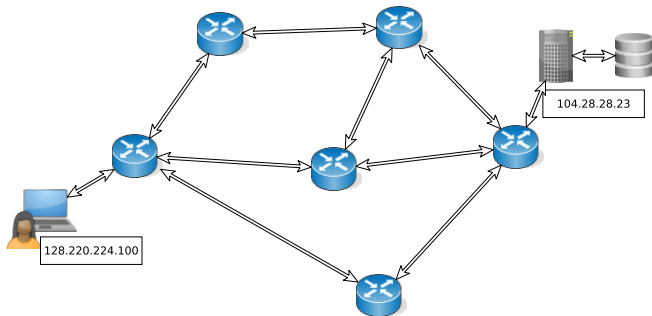

Network with client, server, and intermediate routers



# Routing

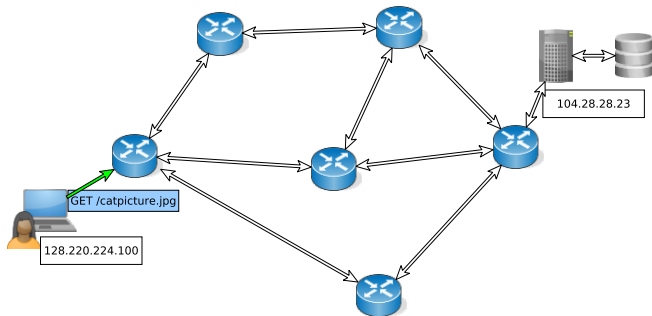

Client sends request to server: packet sent on default route  
(user's computer has only one network interface)

# Routing

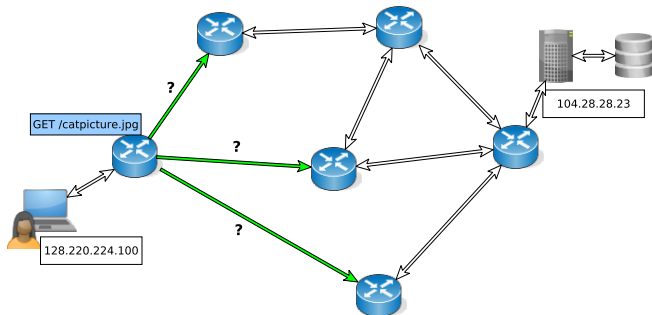

Router has a choice of outgoing links on which to send the packet

Each router has a *routing table* specifying which link to use based on matching the network part of the destination address

*Routing algorithms*: try to deliver packets efficiently, and avoid routing loops

# Routing

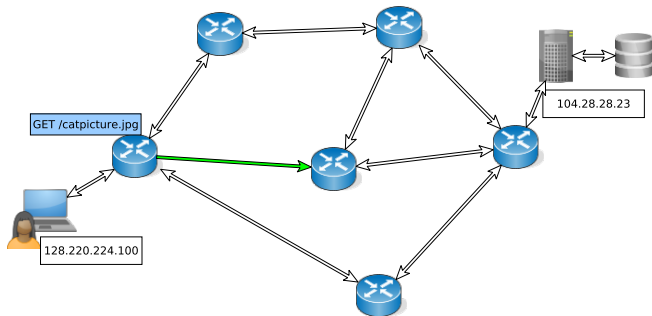

Choose outgoing link based on routing table

# Routing

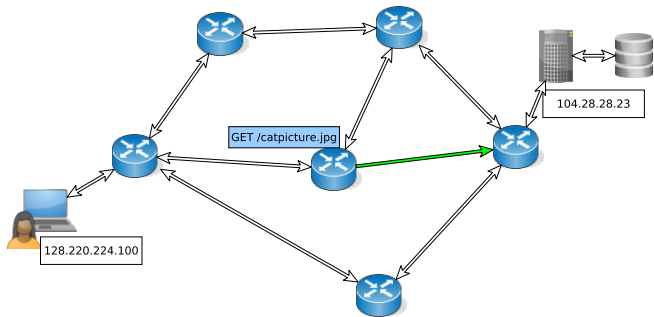

Next hop

# Routing

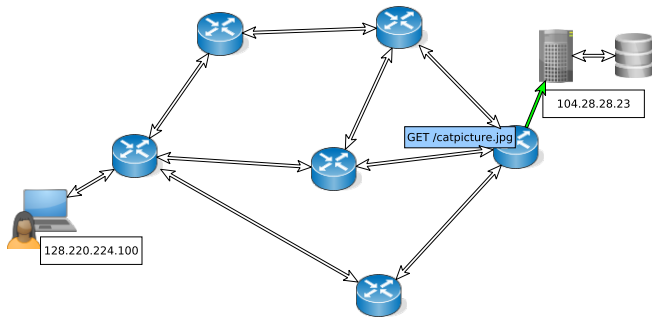

Final hop

# Routing

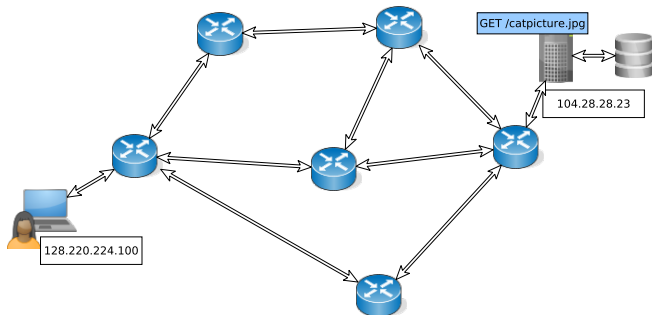

Packet delivered to server

Server's response will be delivered back to client in a similar manner

# Why IP is unreliable

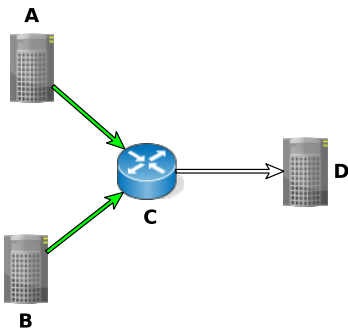

Scenario: A and B both try to send a packet to D at the same time

Outgoing link C→D can only carry one of the two packets

What to do?

# Why IP is unreliable

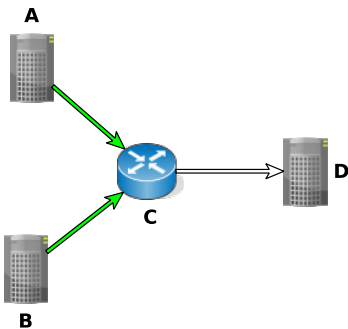

Solution: *queuing*

Router C has a *queue* of unsent packets to be forwarded to D

Either A's packet or B's packet will need to wait in the queue



# Why IP is unreliable

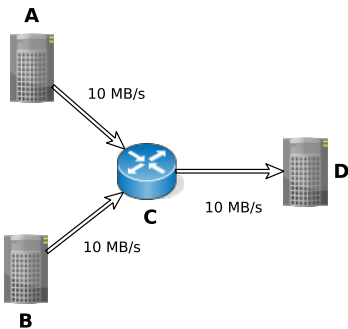

Problem: outgoing link  $C \rightarrow D$  cannot handle aggregate data rate of incoming data from  $A \rightarrow C$  and  $B \rightarrow C$

But, C's queue of packets waiting to be sent to D is finite! (An unbounded queue would imply unbounded delay, not good)

Solution: C discards packets to D when its queue is full

# Dropped packets

Dropped packets are a necessary consequence of finite capacity links and finite queues

Reliable protocols such as TCP require acknowledgment of data sent

No acknowledgment  $\rightarrow$  assume packet dropped, retransmit

# Zoom poll!

Which of the following is a true statement about TCP/IP?

- A. IP datagrams will arrive eventually
- B. A recipient will receive IP datagrams in the order in which they are sent
- C. A recipient will receive data sent via TCP in the order in which it is sent
- D. All of the above
- E. None of the above